

QSI LASER DIODE SPECIFICATIONS FOR APPROVAL

Customer :

Model : QL83D6S-A/B/C

TENTATIVE

Signature of Approval

Approved by _____

Checked by _____

Issued by _____

Approval by Customer



QSI Co., Ltd.

315-9, Cheonheung-ri, Sungger-eup,
Cheonan-city, Chungnam, Korea 330-836

WWW.QSILaser.com

QL83D6S-A/B/C

AlGaAs Laser Diode

Quantum Semiconductor International Co., Ltd.

Ver.1 Jun. 2010

◆ OVERVIEW

QL83D6S-A/B/C is a MOCVD grown 830nm band AlGaAs laser diode with quantum well structure. It's an attractive light source, with a typical light output power of 5mW for industrial optical module and sensor applications.

◆ APPLICATION

- Sensor
- Industrial Optical Module

◆ FEATURES

- Visible Light Output : $\lambda_p = 830 \text{ nm}$
- Optical Power Output : 5mW CW
- Package Type : TO-18 (5.6mm ϕ)
- Built-in Photo Diode for Monitoring Laser Diode

◆ ELECTRICAL CONNECTION

Bottom View

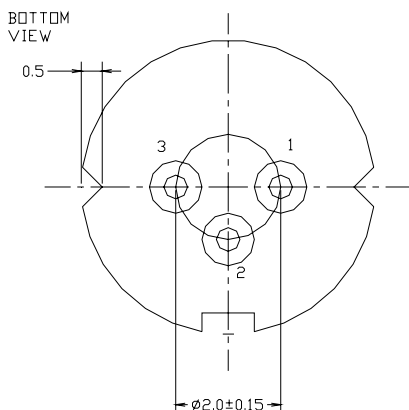

Pin Configuration

A	LD cathode, PD anode (Fig. 1)
B	LD, PD anode (Fig. 2)
C	LD anode, PD cathode (Fig. 3)

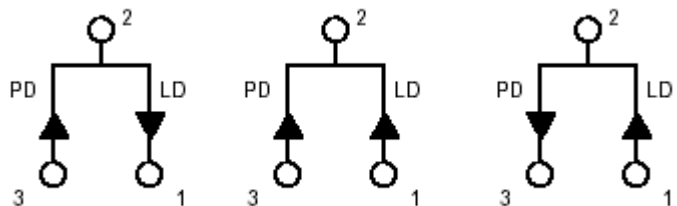

Fig. 1

QL85D6SA

Fig. 2

QL85D6SB

Fig. 3

QL85D6SC

◆ ABSOLUTE MAXIMUM RATING at Tc=25°C

Items	Symbols	Values	Unit
Optical Output Power	P	5	mW
Laser Diode Reverse Voltage	V	2	V
Photo Diode Reverse Voltage	V	30	V
Operating Temperature	Topr	-10 ~ +60	°C
Storage Temperature	Tstg	-40 ~ +85	°C

◆ ELECTRICAL and OPTICAL CHARACTERISTICS at Tc=25°C

Items	Symbols	Min.	Typ.	Max.	Unit	Condition
Optical Output Power	Po	-	5	-	mW	-
Threshold Current	Ith	-	14	20	mA	-
Operating Current	Iop	15	20	28	mA	Po=5mW
Slope Efficiency	SE	0.6	0.8	1.0	mW/mA	2~5 mW
Operating Voltage	Vop	-	1.85	1.95	V	Po=5mW
Lasing Wavelength	λ_p	822	828	834	nm	Po=5mW
Beam Divergence	$\theta_{ }$	6	8	12	deg	Po=5mW
	θ_{\perp}	26	32	38	deg	Po=5mW
Beam Angle	$\Delta\theta_{ }$	-	-	± 2	deg	Po=5mW
	$\Delta\theta_{\perp}$	-	-	± 3	deg	Po=5mW
Monitor Current	I _m	0.1	0.4	0.7	mA	Po=5mW
Astigmatism	As	-	-	15	μm	
Optical Distance	$\Delta X, \Delta Y, \Delta Z$	-	-	± 60	μm	

NOTICE : QL83D6S-A/B/C to be operated on APC

The above product specifications are subject to change without notice.

◆ PACKAGE DIMENSION

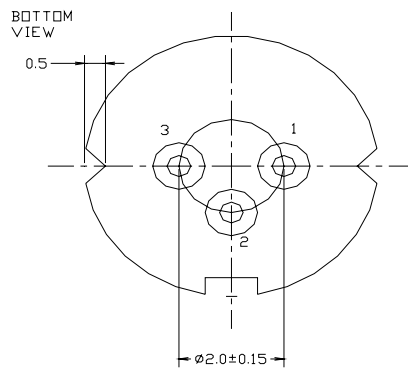
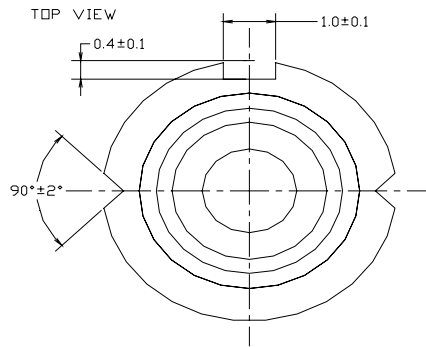
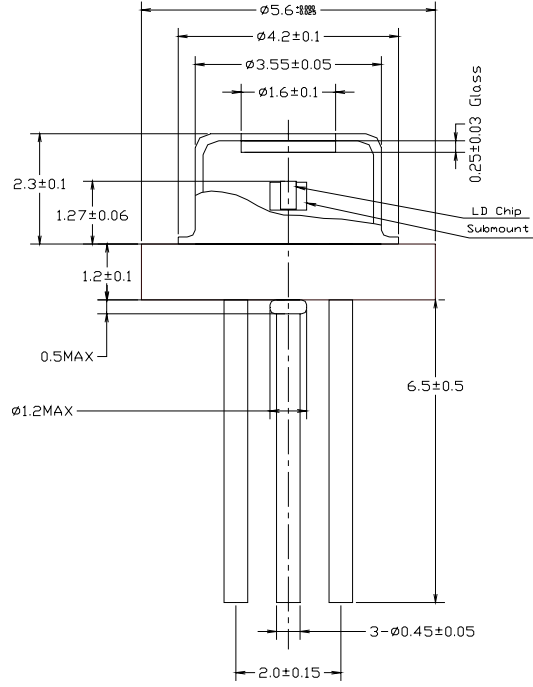

◆PACKING

