

QSI LASER DIODE SPECIFICATIONS FOR APPROVAL

Customer :.

Model : QL65F6S-A/B/C

Signature of Approval

Approved by _____

Checked by _____

Issued by _____

Approval by Customer



QSI Co., Ltd.

315-9, Cheonheung-ri, Sungger-eup,
Cheonan-city, Chungnam, Korea 330-836

WWW.QSILaser.com

QL65F6S-A/B/C

InGaAlP Laser Diode

Quantum Semiconductor International Co., Ltd.

Ver. 0 JAN. 2004

◆ OVERVIEW

QL65F6S-A/B/C is a MOCVD grown 650nm band *InGaAlP* laser diode with quantum well structure. It's an attractive light source, with a typical light output power of 10mW and low operating current for optoelectronic devices such as Optical Pick-up & Bar Code Reader.

◆ APPLICATION

- Optical Pick-up
- Laser Module
- Bar Code Reader

◆ FEATURES

- Visible Light Output : $\lambda_p = 650 \text{ nm}$
- Optical Power Output : 10mW CW
- Package Type : TO-18 (5.6mm ϕ)
- Built-in Photo Diode for Monitoring Laser Diode

◆ ELECTRICAL CONNECTION

Bottom View

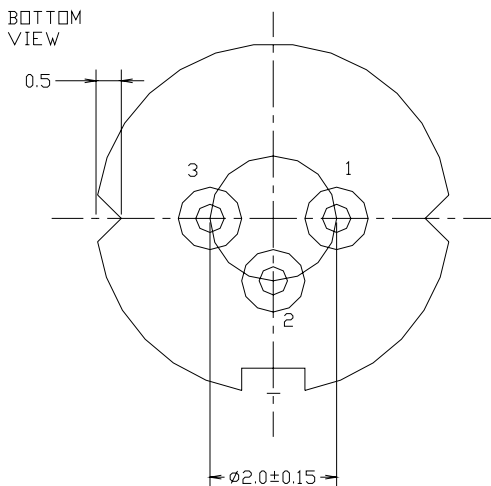

Pin Configuration

A	LD cathode, PD anode (Fig. 1)
B	LD , PD anode (Fig. 2)
C	LD anode, PD cathode (Fig. 3)

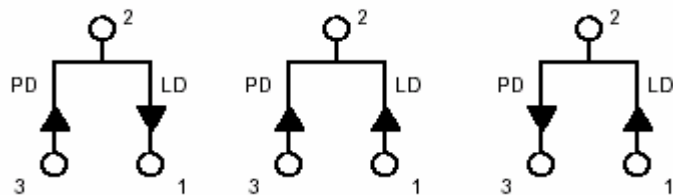

Fig. 1

QL65F6SA

Fig. 2

QL65F6SB

Fig. 3

QL65F6SC

◆ ABSOLUTE MAXIMUM RATING at Tc=25°C

Items	Symbols	Values	Unit
Optical Output Power	P	12	mW
Laser Diode Reverse Voltage	V	2	V
Photo Diode Reverse Voltage	V	30	V
Operating Temperature	Topr	-10 ~ +60	°C
Storage Temperature	Tstg	-40 ~ +85	°C

◆ ELECTRICAL and OPTICAL CHARACTERISTICS at Tc=25°C

Items	Symbols	Min.	Typ.	Max.	Unit	Condition
Optical Output Power	Po	-	10	-	mW	-
Threshold Current	Ith	-	40	50	mA	-
Operating Current	Iop	-	60	80	mA	Po=10mW
Operating Voltage	Vop	-	2.3	2.6	V	Po=10mW
Lasing Wavelength	λ_p	645	655	660	nm	Po=10mW
Beam Divergence	$\theta_{ }$	6	9	12	deg	Po=10mW
	θ_{\perp}	24	28	35	deg	Po=10mW
Beam Angle	$\Delta\theta_{ }$	-	-	±1.5	deg	Po=10mW
	$\Delta\theta_{\perp}$	-	-	±2.5	deg	Po=10mW
Monitor Current	I _m	0.1	0.2	0.5	mA	Po=10mW
Optical Distance	$\Delta X, \Delta Y, \Delta Z$	-	-	±60	μm	-

NOTICE : QL65F6S-A/B/C to be operated on APC

The above product specifications are subject to change without notice.

◆ EXAMPLE of REPRESENTATIVE CHARACTERISTICS

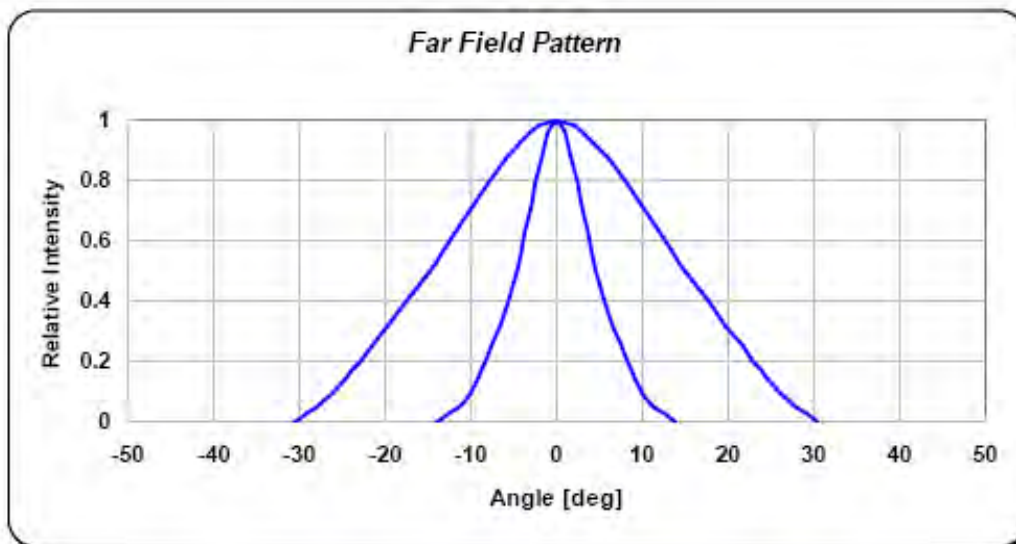
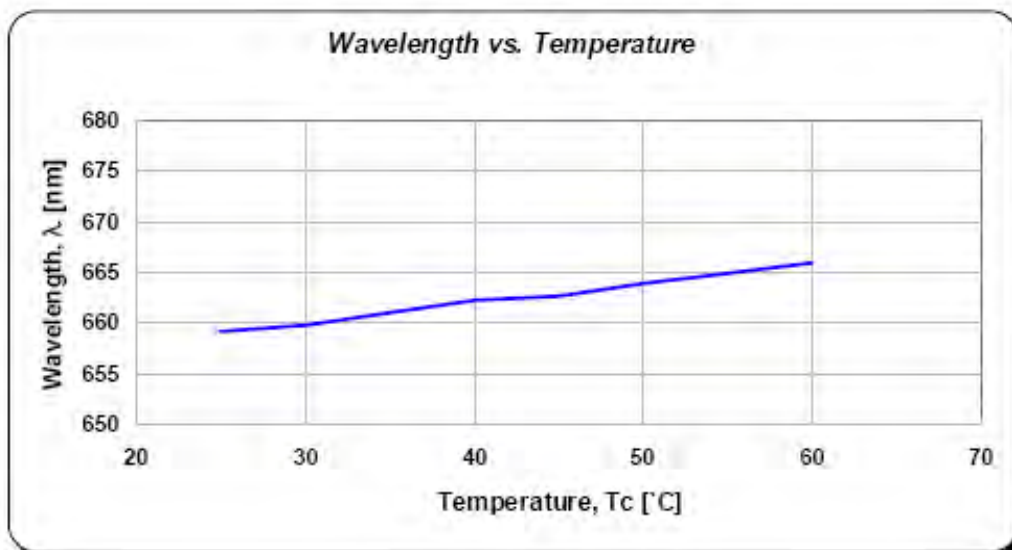
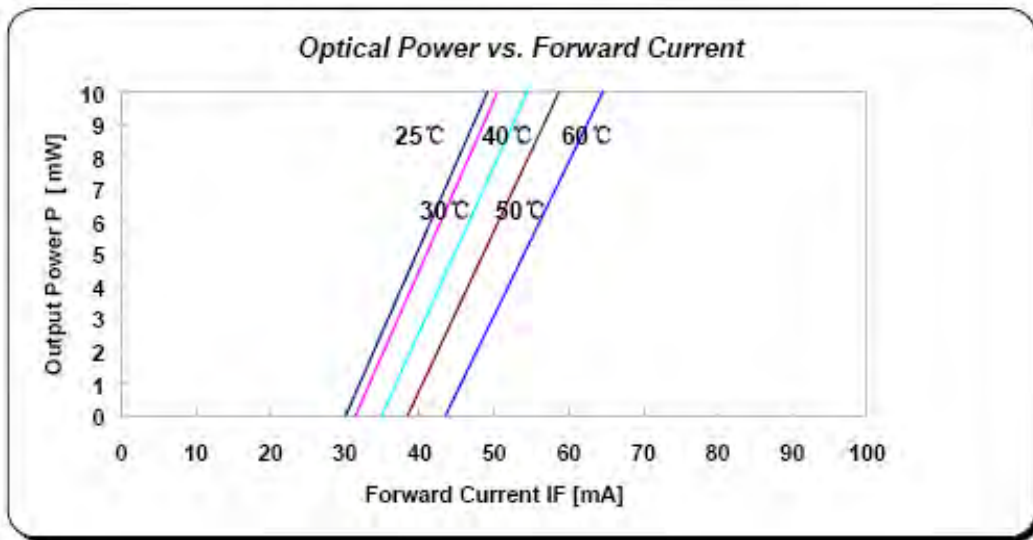

Monitor Current vs. Optical Output Power

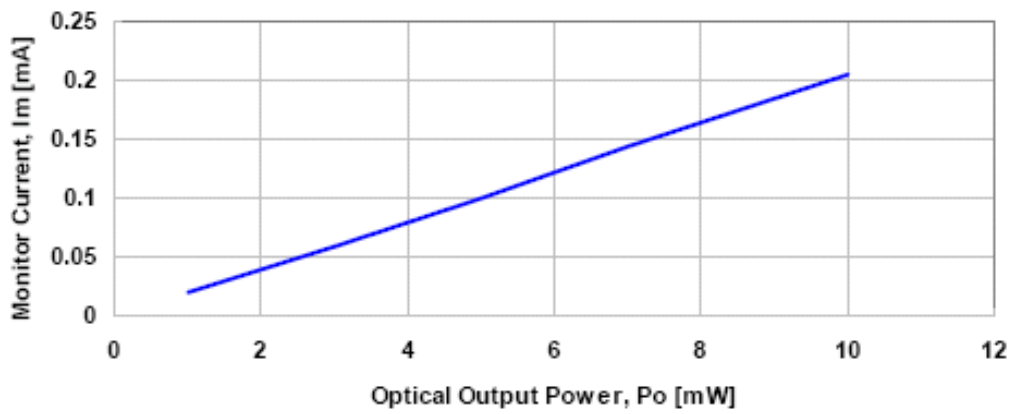

Operating Voltage vs. Temperature

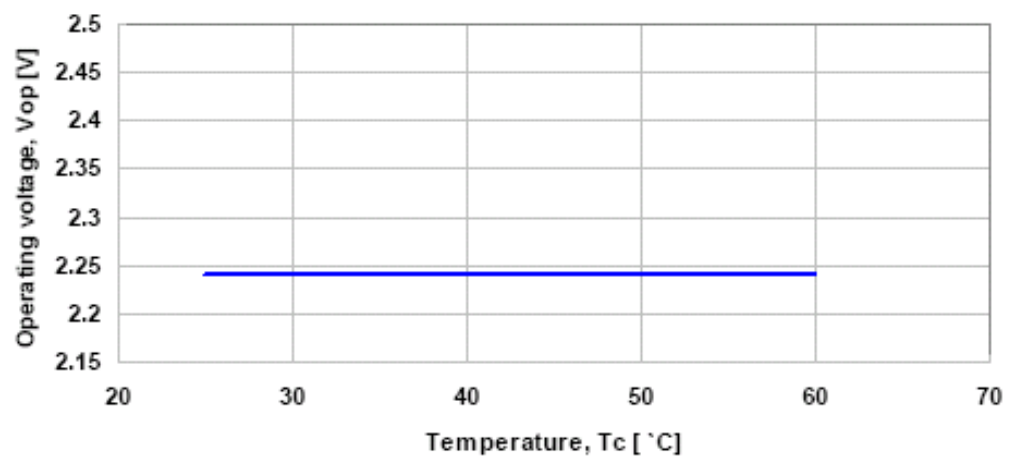

Threshold Current vs. Temperature

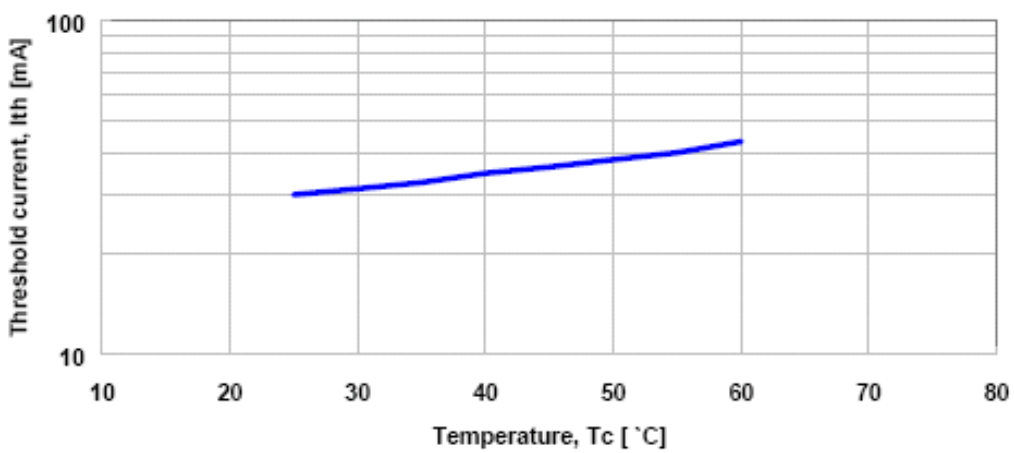

◆ PACKAGE DIMENSION

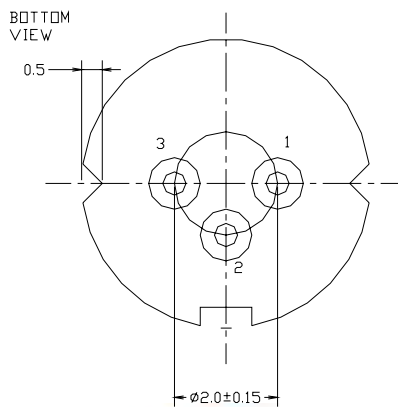
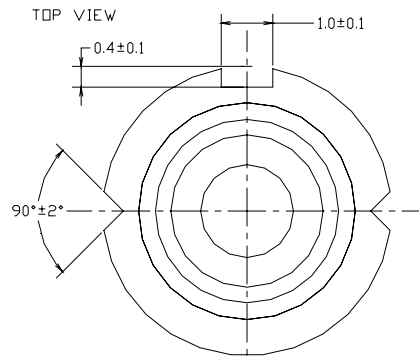
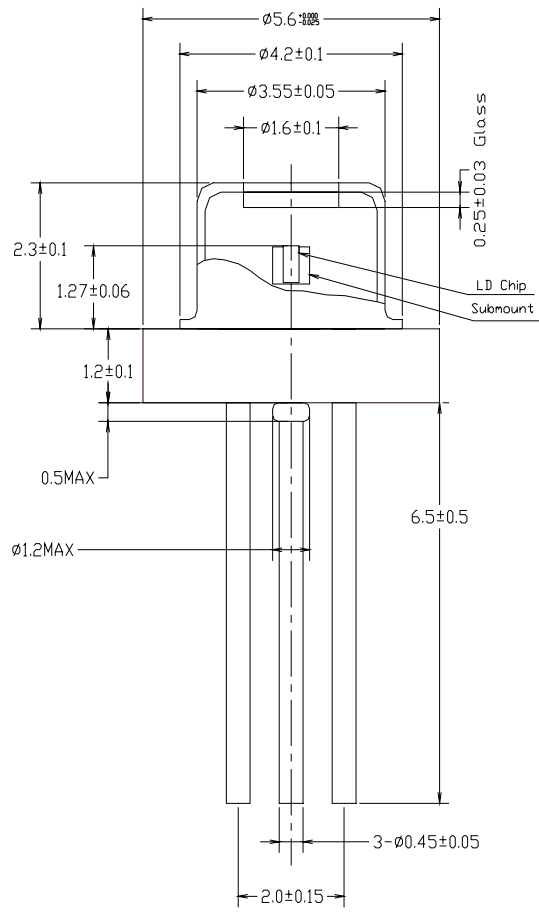

◆PACKING

