

CUSTOMER : _____.

DATE : '15. 03. 09 .

REV : REV. 1.0 .

SPECIFICATIONS FOR APPROVAL





Top View Type White SMD LED

MODEL NAME : LEMWS59R80LZ3D00

RoHS
Compliant

| APPROVAL | REMARK | APPENDIX |
|----------|--------|----------|
| | | |
| | | |

| DESIGNED | CHECKED | APPROVED |
|---|--|---|
| '15.03.09 | '15.03.09 | '15.03.09 |
| S.H. Han | C.Y. Kim | B.G. Min |
|  |  |  |

CONTENTS

| | | |
|--|-------|-------|
| 1. Features | ----- | 2 |
| 2. Outline Dimensions | ----- | 2 |
| 3. Applications | ----- | 3 |
| 4. Absolute Maximum Ratings | ----- | 3 |
| 5. Electro-Optical Characteristics | ----- | 3~4 |
| 6. Bin Structures | ----- | 4~5 |
| 7. Typical Characteristic Curves | ----- | 6~7 |
| 8. Reliability Test Items and Conditions | ----- | 8 |
| 9. Packing and Labeling of Products | ----- | 9~12 |
| 10. Cautions on Use | ----- | 13~16 |
| 11. Disclaimers | ----- | 16 |

1. Features

- Lighting Color : White
- Lead Frame Type LED Package : 5.6×3.0×0.9 mm (L×W×H) [Unit : mm]
- Viewing angle : 120°
- Chip Material : InGaN
- Soldering Methods : Reflow Soldering
- Taping : 12 mm conductive black carrier tape & antistatic clear cover tape
3,000 pcs/reel, Φ178 mm Reel

2. Outline Dimensions

(Unit : mm)

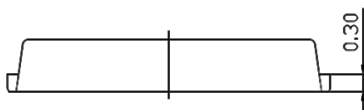
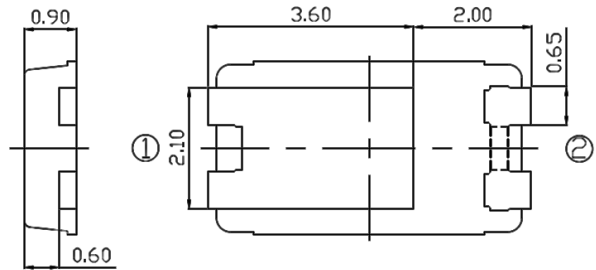
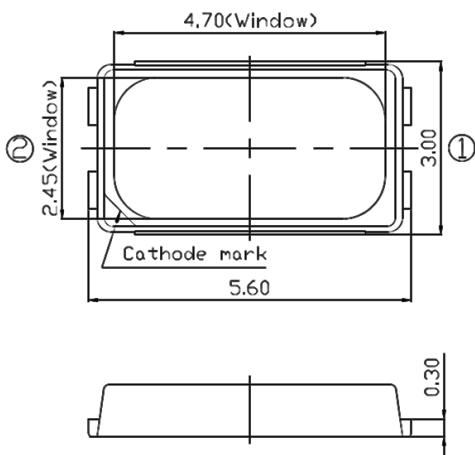

Internal circuit

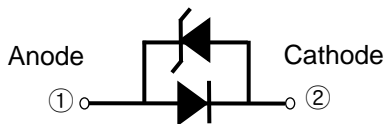

Pad Configuration

- ① Anode Pad
- ② Cathode Pad

Recommendable soldering pattern (For reflow soldering)

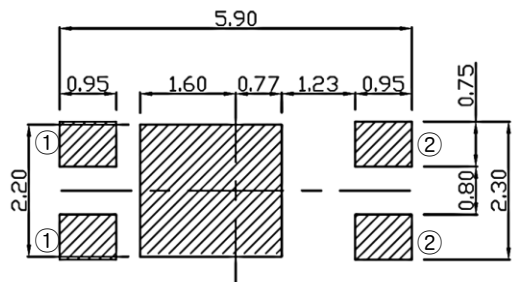

▪ Tolerances unless otherwise specified ± 0.10 mm

3. Applications

- Interior and Exterior Illumination

4. Absolute Maximum Ratings

(Ta=25°C)

| Item | Symbol | Rating | Unit |
|--------------------------|-----------------------|------------|------|
| Forward Current | If | 200 | mA |
| Pulse Forward Current*1) | I _{fp} | 260 | mA |
| Operating Temperature | T _{opr} | -40 ~ +85 | °C |
| Storage Temperature | T _{stg} | -40 ~ +100 | °C |
| Junction Temperature | T _j | 110 | °C |
| Soldering Temperature | JEDEC-J-STD-020D | | |
| ESD Classification | Class 2 (JESD22-A114) | | |

*1) Pulse width ≤10ms and duty cycle ≤10%

※ Operating the LED beyond the listed maximum ratings may affect device reliability and cause permanent damage. These or any other conditions beyond those indicated under recommended operating conditions are not implied. The exposure to the absolute maximum rated conditions may affect device reliability.

※ The LEDs are not designed to be driven in reverse bias.

5. Electro - Optical Characteristics

(Ta=25°C)

| Item | Symbol | Condition | Min. | Typ. | Max. | Unit |
|---|-----------------------------------|-----------------------|-----------------------------|-------|-------|-------|
| Forward Voltage | V _f | I _f = 65mA | 2.70 | 2.80 | 3.00 | V |
| Luminous Flux | Φ _v | I _f = 65mA | 31.8 | 32.6 | 33.4 | lm |
| Luminous Intensity | I _v | I _f = 65mA | 10.08 | 10.32 | 10.56 | cd |
| Color | C _x / C _y | I _f = 65mA | Refer to '6. Bin structure' | | | - |
| Viewing Angle | 2Θ _{1/2} | I _f = 65mA | - | 120 | - | deg |
| Color Rendering Index (Ra) | R _a | I _f = 65mA | 80 | - | - | - |
| Thermal Resistance, Junction to Solder Point | R _{th j-s} | I _f = 65mA | - | 15 | - | °C/W |
| Typical Temperature Coefficient of Forward Voltage*1) | ΔV _f / ΔT _j | I _f = 65mA | -1.0 | - | -3.0 | mV/°C |

*1) Measured at Ta between 25°C and 85°C.

※ These values are measured by the LG Innotek optical spectrum analyzer within the following tolerances. Luminous Flux (Φ_v) : ±7%, Forward Voltage (V_f) : ±0.1V, Color Value : ±0.005, CRI Value : ±2,

※ Although all LEDs are tested by LG Innotek equipment, some values may vary slightly depending on the conditions of the test equipment.

5. Electro - Optical Characteristics

(Ta=25°C)

| If (mA) | Vf (V) | Power (W) | Φv (lm) | lm/W |
|---------|--------|-----------|---------|------|
| 30 | 2.67 | 0.080 | 15.5 | 193 |
| 65 | 2.80 | 0.182 | 32.6 | 179 |
| 100 | 2.90 | 0.290 | 48.6 | 168 |
| 150 | 3.04 | 0.455 | 69.8 | 153 |
| 200 | 3.14 | 0.629 | 89.2 | 142 |

※ Φv values are for representative references only.

6. Bin Structure

▪ Forward Voltage Bins(@65mA)

| Bin | Vf (V) | |
|-----|--------|------|
| | Min. | Max. |
| 8A | 2.70 | 2.75 |
| 8B | 2.75 | 2.80 |
| 9A | 2.80 | 2.85 |
| 9B | 2.85 | 2.90 |
| 0A | 2.90 | 2.95 |
| 0B | 2.95 | 3.00 |

▪ Luminous Flux Bin(@65mA)

| Bin | Φv | |
|-----|------|------|
| | Min. | Max. |
| R4 | 31.8 | 33.4 |

▪ CRI Bin(@65mA)

| Bin | CRI | |
|-----|------|------|
| | Min. | Max. |
| 80 | 80 | - |

▪ Color Bins (@65mA)

| Bin | Cx | Cy | Bin | Cx | Cy |
|-----|--------|--------|-----|--------|--------|
| L11 | 0.4299 | 0.4165 | L31 | 0.4430 | 0.4212 |
| | 0.4364 | 0.4189 | | 0.4496 | 0.4236 |
| | 0.4323 | 0.4098 | | 0.4450 | 0.4144 |
| | 0.4260 | 0.4075 | | 0.4387 | 0.4122 |
| L12 | 0.4260 | 0.4075 | L32 | 0.4387 | 0.4122 |
| | 0.4323 | 0.4098 | | 0.4450 | 0.4144 |
| | 0.4282 | 0.4008 | | 0.4404 | 0.4052 |
| | 0.4221 | 0.3984 | | 0.4344 | 0.4032 |
| L13 | 0.4364 | 0.4189 | L33 | 0.4496 | 0.4236 |
| | 0.4430 | 0.4212 | | 0.4562 | 0.4260 |
| | 0.4387 | 0.4122 | | 0.4513 | 0.4166 |
| | 0.4323 | 0.4098 | | 0.4450 | 0.4144 |
| L14 | 0.4323 | 0.4098 | L34 | 0.4450 | 0.4144 |
| | 0.4387 | 0.4122 | | 0.4513 | 0.4166 |
| | 0.4344 | 0.4032 | | 0.4465 | 0.4071 |
| | 0.4282 | 0.4008 | | 0.4404 | 0.4052 |
| L21 | 0.4221 | 0.3984 | L41 | 0.4344 | 0.4032 |
| | 0.4282 | 0.4008 | | 0.4404 | 0.4052 |
| | 0.4243 | 0.3921 | | 0.4360 | 0.3962 |
| | 0.4184 | 0.3899 | | 0.4302 | 0.3943 |
| L22 | 0.4184 | 0.3899 | L42 | 0.4302 | 0.3943 |
| | 0.4243 | 0.3921 | | 0.4360 | 0.3962 |
| | 0.4203 | 0.3834 | | 0.4316 | 0.3873 |
| | 0.4147 | 0.3814 | | 0.4260 | 0.3853 |
| L23 | 0.4282 | 0.4008 | L43 | 0.4404 | 0.4052 |
| | 0.4344 | 0.4032 | | 0.4465 | 0.4071 |
| | 0.4302 | 0.3943 | | 0.4419 | 0.3982 |
| | 0.4243 | 0.3921 | | 0.4360 | 0.3962 |
| L24 | 0.4243 | 0.3921 | L44 | 0.4360 | 0.3962 |
| | 0.4302 | 0.3943 | | 0.4419 | 0.3982 |
| | 0.4260 | 0.3853 | | 0.4373 | 0.3893 |
| | 0.4203 | 0.3834 | | 0.4316 | 0.3873 |

※ Bin structure: Please refer to the following example.

Bin Code : R4-L11-0A

(Φv Bin = R4, Color Bin = L11, Vf Bin = 0A)

Color Bins Structure

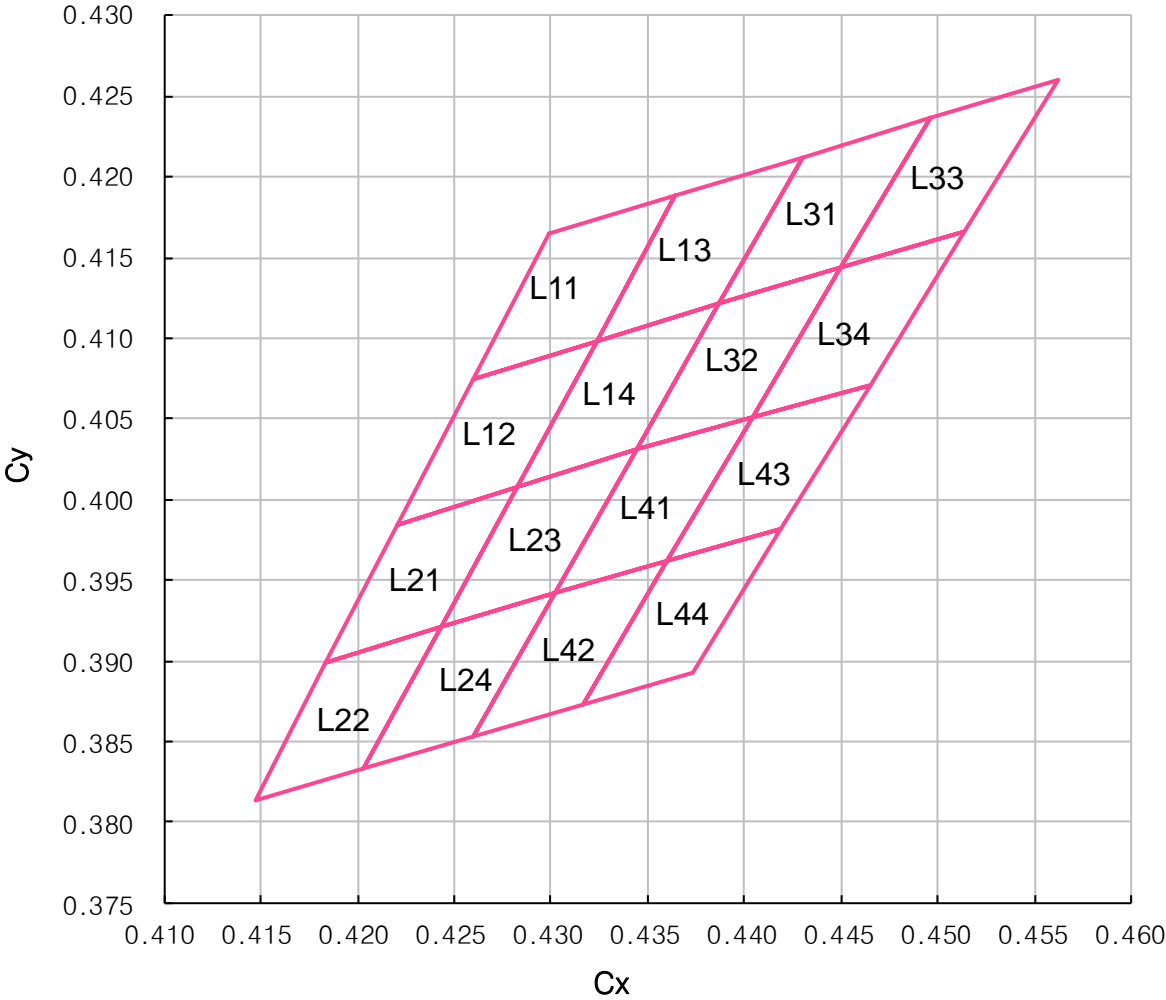

7. Typical Characteristic Curves

- Forward Current vs. Forward Voltage

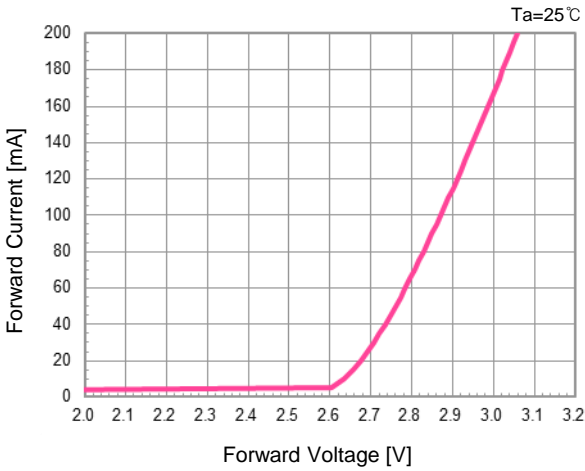

- Relative Luminous Flux vs. Forward Current

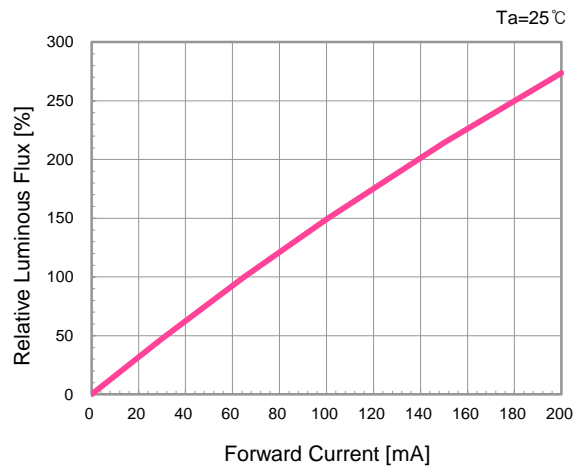

- Spectrum

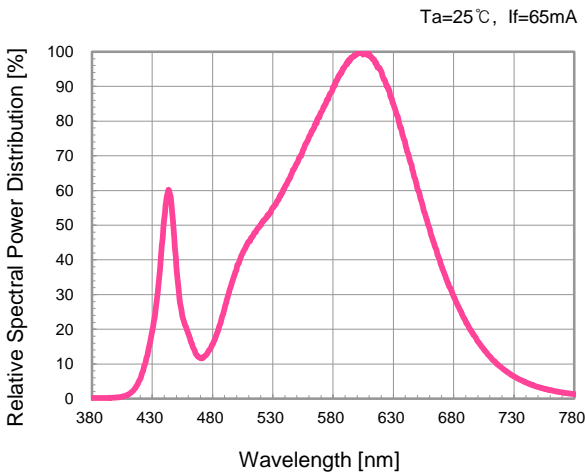

- Chromaticity Coordinate vs. Forward Current

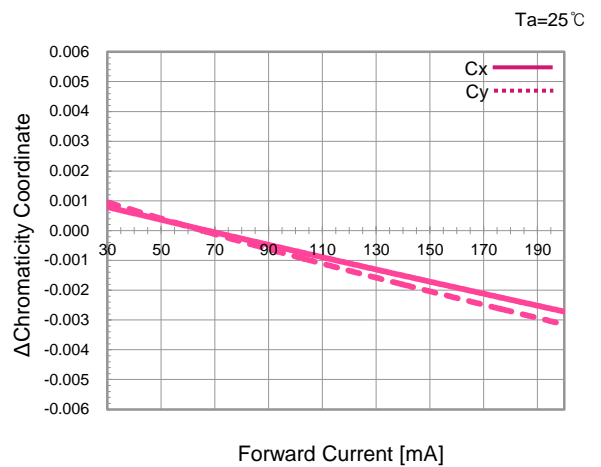

- Radiation Characteristics

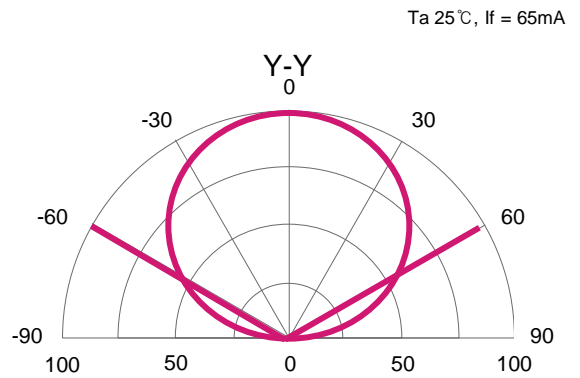
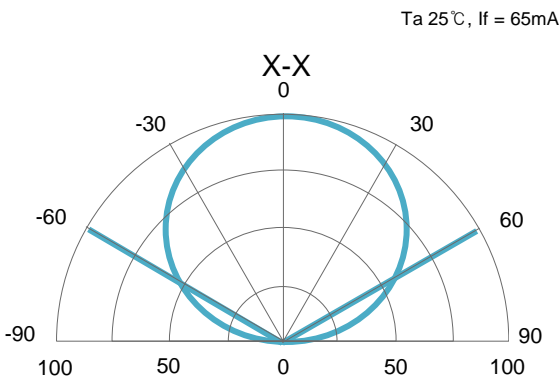

7. Typical Characteristic Curves

▪ Luminous Flux vs. Temperature

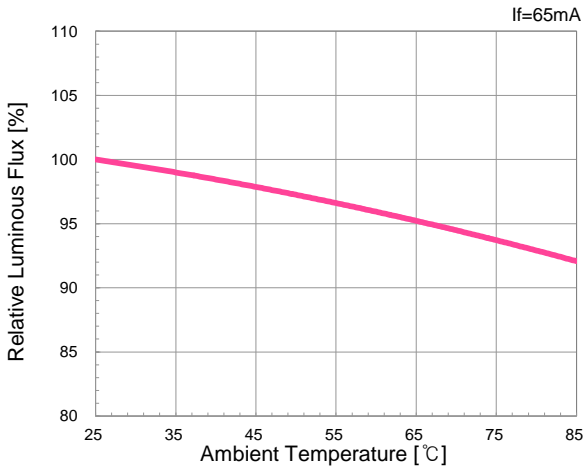

▪ Chromaticity Coordinate vs. Temperature

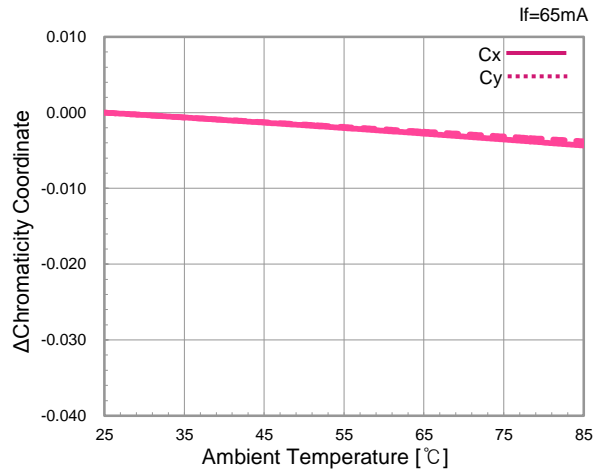

▪ Forward Voltage vs. Temperature

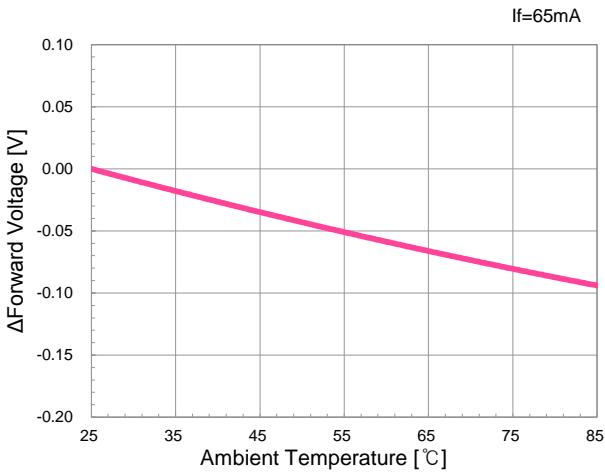

▪ Derating Curve

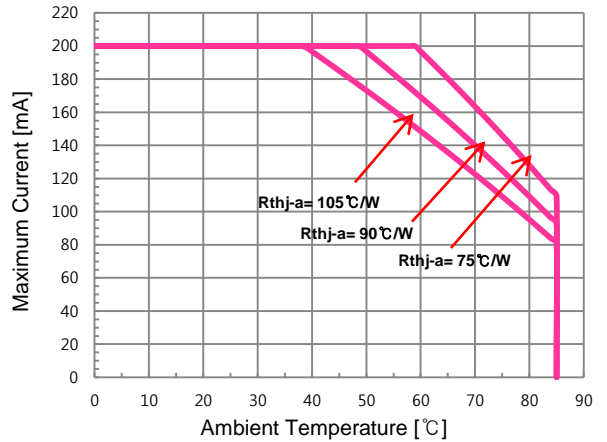

※ The ambient temperature values for each graph are obtained with LG Innotek equipment.

8. Reliability Test Items and Conditions

8-1. Failure Criteria

| Items | Symbols | Test Conditions | Limits | |
|-----------------|----------------|-----------------------|---------------------|---------------------|
| | | | Min. | Max. |
| Forward Voltage | V _f | I _f = 65mA | - | Initial Value × 1.1 |
| Luminous Flux | Φ _v | I _f = 65mA | Initial Value × 0.7 | - |

8-2. Reliability Test

| No | Items | Test Conditions | Test Hours /Cycles |
|----|---|--|--------------------|
| 1 | Room Temperature Operating Life (RTOL) | T _a = 25 °C, I _f = 200mA | 1,000 Hours |
| 2 | Wet High Temperature Operating Life (WHTOL) | T _a = 60 °C, RH = 90%, I _f = 200mA | 1,000 Hours |
| 3 | High Temperature Operating Life (HTOL) | T _a = 85 °C, I _f = 200mA | 1,000 Hours |
| 4 | Low Temperature Operating Life (LTOL) | T _a = -40 °C, I _f = 200mA | 1,000 Hours |
| 5 | High Temperature Storage Life (HTSL) | T _a = 100 °C | 1,000 Hours |
| 6 | Low Temperature Storage Life (LTSL) | T _a = -40 °C | 1,000 Hours |
| 7 | Wet High Temperature Storage Life (WHTSL) | T _a = 85 °C, RH = 85% | 1,000 Hours |
| 8 | Thermal Shock (TMSK) | 100 °C ~ -40 °C Dwell : 15 min., Transfer : 10 sec. | 200 Cycles |
| 9 | Moisture Sensitivity Level (MSL) | T _{sld} = 260 °C (Pre treatment 60 °C, 60%, 168 hours) | 3 Times |
| 10 | Vibration | 100~2000~100Hz Sweep 4min. 200m/s ² , 3 directions | 48 Minutes |

※ All samples are tested using LG Innotek Standard Metal PCB (25x25x1.6 mm³(L×W×H)) except MSL test .

※ All samples must pass each test item and all test items must be satisfied.

9. Packing and Labeling of Products

9-1. Taping Outline Dimensions

Reel

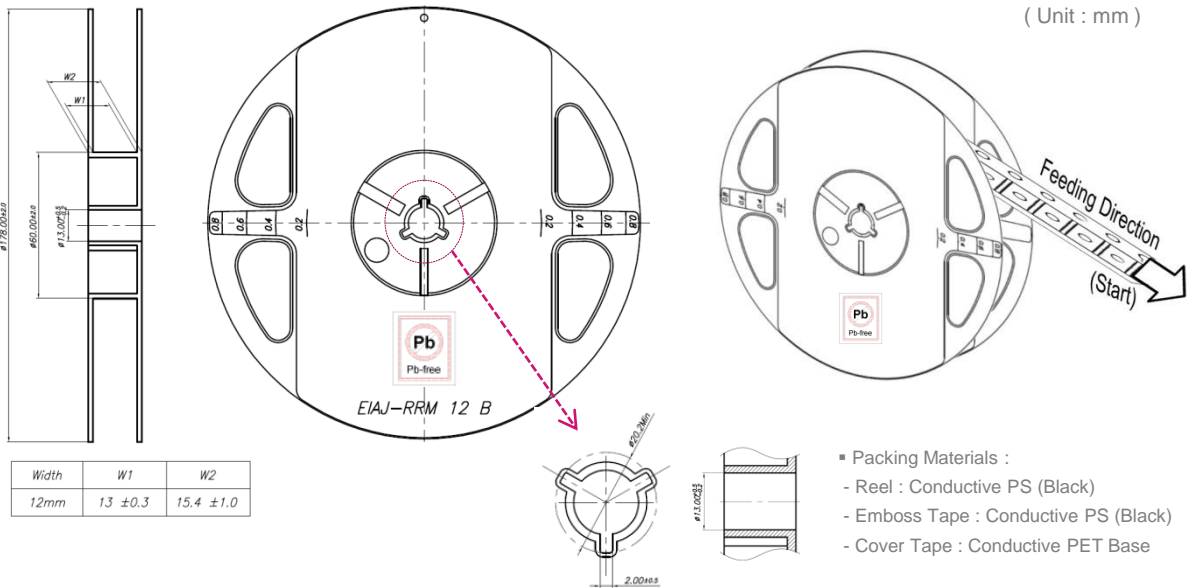

Tape

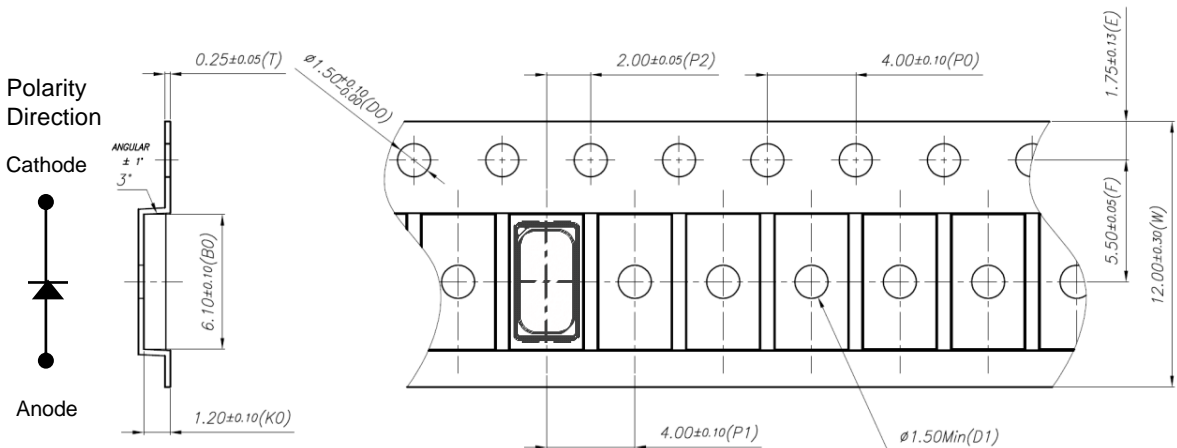

Taping Arrangement

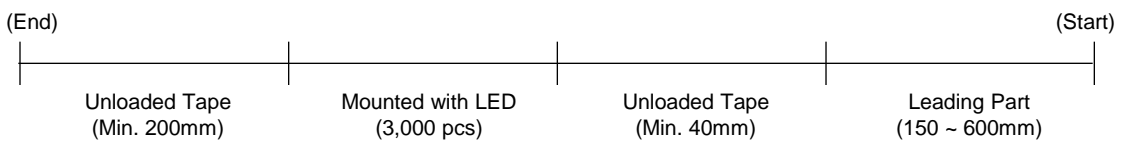

9. Packing and Labeling of Products

9-2. Label Structure

※. Label A

Specifying Model Name, Rank, Rack, Quantity and Run number

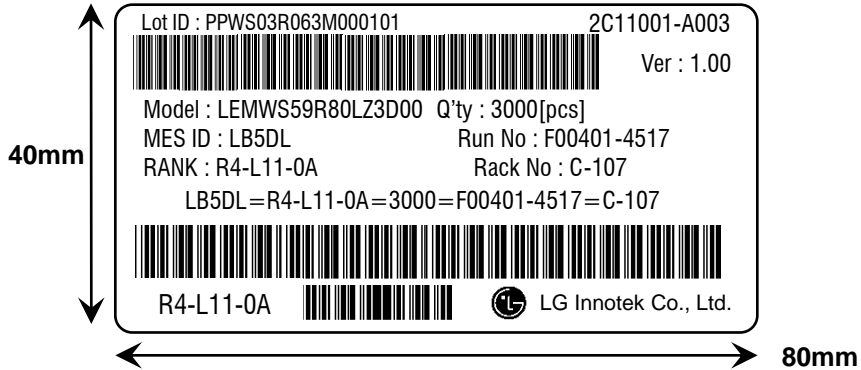

▪ Run No. indication

| | | | | | | | | | | |
|------|-------------------------|---|---|------------------|---|---|-------------|---|-------------|----|
| 1 | 2 | 3 | 4 | 5 | 6 | — | 7 | 8 | 9 | 10 |
| Code | Manufacture Site | Manufacture Year | Manufacture Month | Manufacture date | | | TH # | | Serial No | |
| | Paju : 1 Huizhou : 9 | 2013 : 3 ... 2020 : 0 2021 : 1 | 1-9 : 1-9 10 : A 11 : B 12 : C | (01-31) | | | (00 ~ 99) | | (00 ~ ZZ) | |

9. Packing and Labeling of Products

9-2. Label Structure

※. Label C

Specifying Customer, Date, Model Name, Quantity, Customer Part no, Outbox ID, Rank/Rank Q'ty

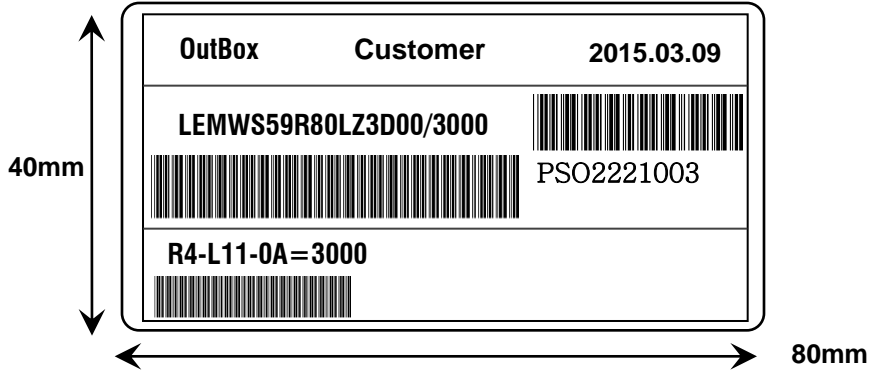

▪ Box ID. indication

| 1 | 2 | 3 | 4 | 5 | 6 | 7 | 8 | 9 | 10 |
|-------------------------|------------|--------------------------------|---|---|-------------|---|---------------|---|----|
| Manufacture Site | PKG Site | Box | Year | Month | Date | | Serial No | | |
| Paju : P Huizhou : H | PKG : S, P | Inner Box : I Outer Box : O | 2013 : 3 ... 2020 : 0 2021 : 1 | 1~9 : 1~9 10 : A 11 : B 12 : C | (01 ~ 31) | | (001 ~ 999) | | |

9. Packing and Labeling of Products

9-3. Packing Structures

Reeled products are packed in a sealed-off and moisture-proof aluminum bag with desiccants (silica gel). Max four aluminum bags are packed in an inner box and six inner boxes are packed in an outer box.

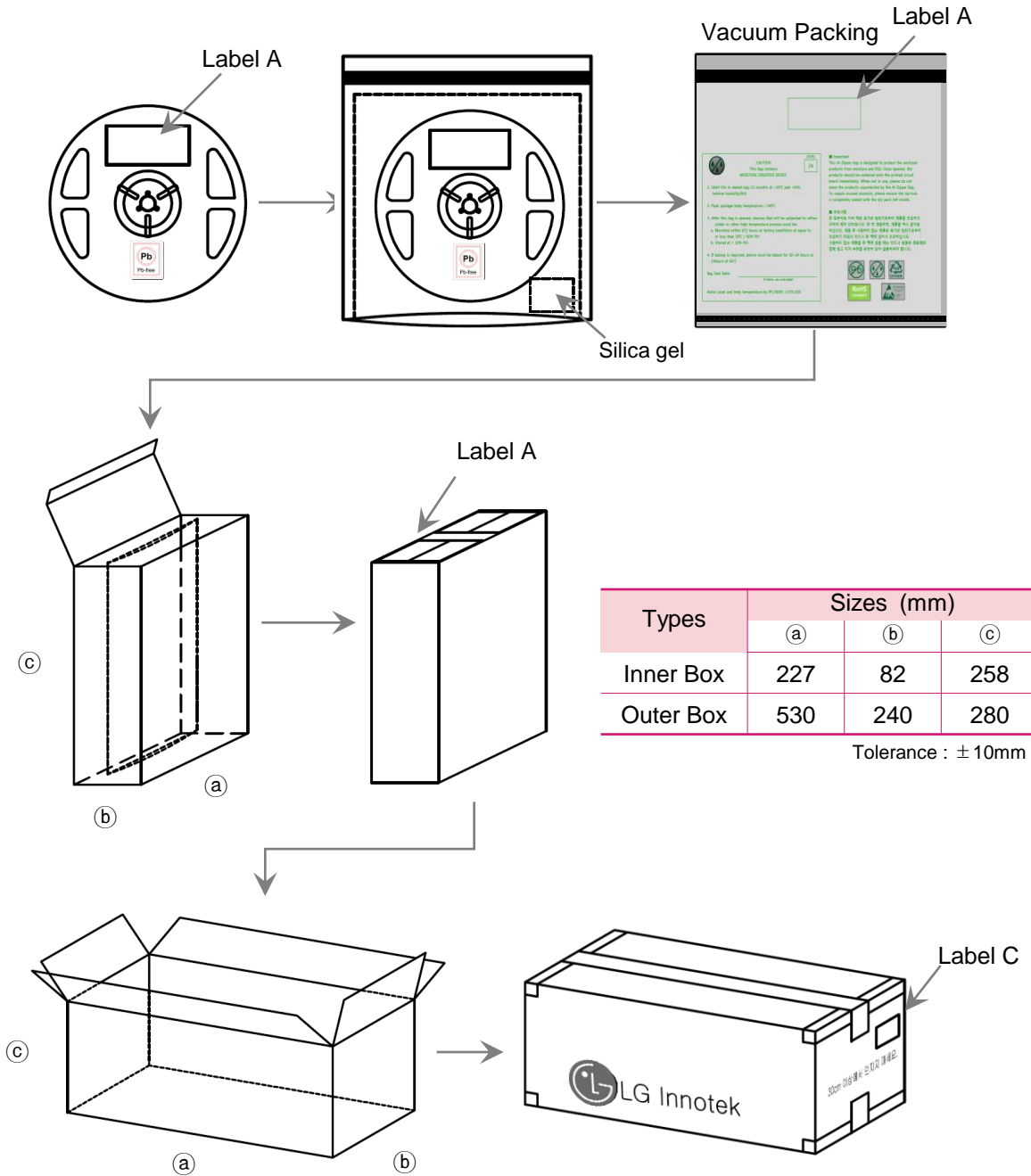

10. Cautions on Use

10-1. Moisture-Proof Package

- The moisture in the SMD package may vaporize and expand during soldering.
- The moisture can damage the optical characteristics of the LEDs due to the encapsulation.

10-2. During Storage

| Conditions | | Temperature | Humidity | Time |
|------------|-----------------------------|-------------|----------|--------------------------------------|
| Storage | Before Opening Aluminum Bag | 5°C ~ 30°C | < 50%RH | Within 1 Year from the Delivery Date |
| | After Opening Aluminum Bag | 5°C ~ 30°C | < 60%RH | ≤ 672 hours |
| Baking | | 65 ± 5°C | < 10%RH | 10 ~ 24 hours |

10-3. During Usage

- The LED should avoid direct contact with hazardous materials such as sulfur, chlorine, phthalate, etc.
- The metal parts on the LED can rust when exposed to corrosive gases. Therefore, exposure to corrosive gases must be avoided during operation and storage.
- The silver-plated metal parts also can be affected not only by the corrosive gases emitted inside of the end-products but by the gases penetrated from outside environment.
- Extreme environments such as sudden ambient temperature changes or high humidity that can cause condensation must be avoided.

10-4. Cleaning

- Do not use brushes for cleaning or organic solvents (i.e. Acetone, TCE, etc..) for washing as they may damage the resin of the LEDs.
- Isopropyl Alcohol(IPA) is the recommended solvent for cleaning the LEDs under the following conditions.
Cleaning Condition : IPA, 25°C max. × 60sec max.
- Ultrasonic cleaning is not recommended.
- Pretests should be conducted with the actual cleaning process to validate that the process will not damage the LEDs.

10. Cautions on Use

10-5. Thermal Management

- The thermal design of the end product must be seriously considered, particularly at the beginning of the system design process.
- The generation of heat is greatly impacted by the input power, the thermal resistance of the circuit boards and the density of the LED array combined with other components.

10-6. Static Electricity

- Wristbands and anti-electrostatic gloves are strongly recommended and all devices, equipment and machinery must be properly grounded when handling the LEDs, which are sensitive against static electricity and surge.
- Precautions are to be taken against surge voltage to the equipment that mounts the LEDs.
- Unusual characteristics such as significant increase of current leakage, decrease of turn-on voltage, or non-operation at a low current can occur when the LED is damaged.

10-7. Recommended Circuit

- The current through each LED must not exceed the absolute maximum rating when designing the circuits.
- In general, there can be various forward voltages for LEDs. Different forward voltages in parallel via a single resistor can result in different forward currents to each LED, which also can output different luminous flux values. In the worst case, the currents can exceed the absolute maximum ratings which can stress the LEDs. Matrix circuit with a single resistor for each LED is recommended to avoid the luminous flux fluctuations.

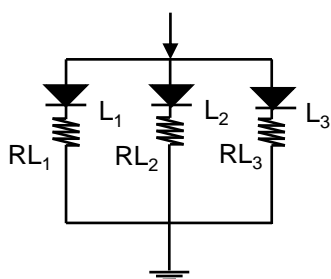

Fig.1 Recommended Circuit in Parallel Mode
: Separate resistors must be used for each LED.

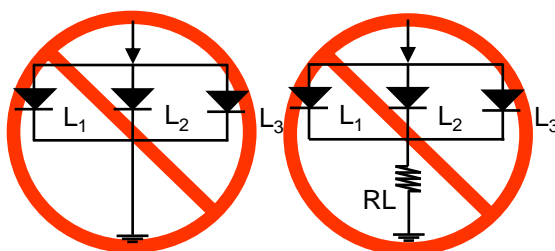

Fig.2 Abnormal Circuit
Circuits to Avoid : The current through the LEDs may vary due to the variation in LED forward voltage.

- The driving circuits must be designed to operate the LEDs by forward bias only.
- Reverse voltages can damage the zener diode, which can cause the LED to fail.
- A constant current LED driver is recommended to power the LEDs.

10. Cautions on Use

10-8. Soldering Conditions

- Reflow soldering is the recommended method for assembling LEDs on a circuit board.
- LG Innotek does not guarantee the performance of the LEDs assembled by the dip soldering method.
- Recommended Soldering Profile (according to JEDEC J-STD-020D)

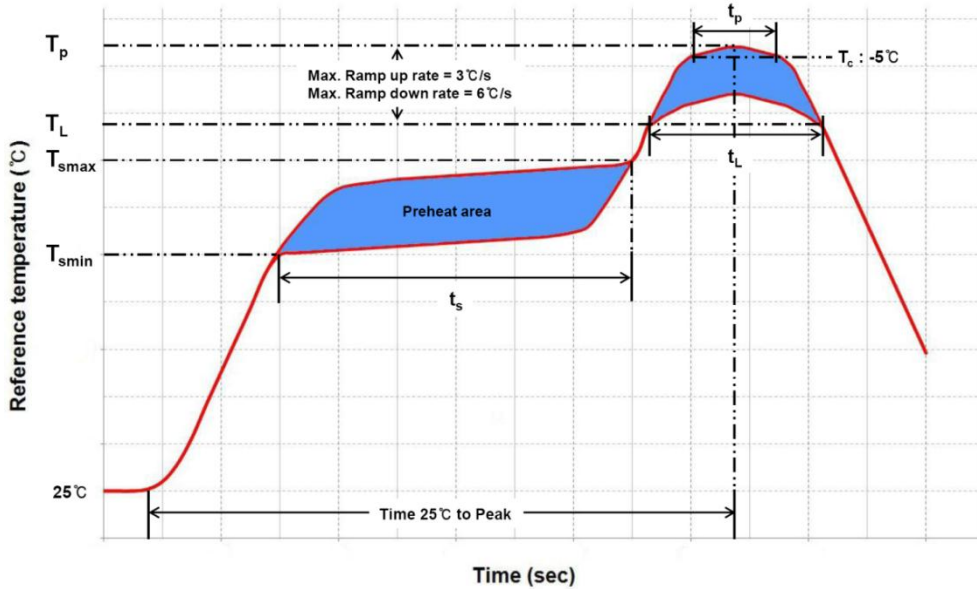

| Profile Feature | Pb-Free Assembly | Pb-Based Assembly |
|--|------------------|-------------------|
| Preheat / Soak | | |
| Temperature Min (T_{smin}) | 150°C | 100°C |
| Temperature Max (T_{smax}) | 200°C | 150°C |
| Maximum time (t_s) from T_{smin} to T_{smax} | 60~120 seconds | 60~120 seconds |
| Ramp-up rate (T_L to T_p) | 3°C/ second max. | 3°C/ second max. |
| Liquidous temperature (T_L) | 217°C | 183°C |
| Time (t_L) maintained above T_L | 60~150 seconds | 60~150 seconds |
| Maximum peak package body temperature (T_p) | 260°C | 235°C |
| Time (t_p) within 5°C of the specified temperature (T_c) | 30 seconds | 20 seconds |
| Ramp-down rate (T_p to T_L) | 6°C/second max. | 6°C/second max. |
| Maximum Time 25°C to peak temperature | 8 minutes max. | 6 minutes max. |

- Reflow or hand soldering at the lowest possible temperature is desirable for the LEDs although the recommended soldering conditions are specified in the above diagrams.
- A rapid cooling process is not recommended for the LEDs from the peak temperature.
- The silicone encapsulant at the top of the LED package is a soft surface, which can easily be damaged by pressure. Precautions should be taken to avoid strong pressure on the silicone resin when leveraging the pick and place machines.
- Reflow soldering should not be done more than two times.

10. Cautions on Use

10-9. Soldering Iron

- The recommended condition is less than 5 seconds at 260 °C.
- The time must be shorter for higher temperatures. (+10 °C → -1sec).
- The power dissipation of the soldering iron should be lower than 15W and the surface temperature of the device should be controlled at or under 230 °C.

10-10. Eye Safety Guidelines

- Do not directly look at the light when the LEDs are on.
- Proceed with caution to avoid the risk of damage to the eyes when examining the LEDs with optical instruments.

10-11. Manual Handling

- Use Teflon-type tweezers to grab the base of the LED and do not apply mechanical pressure on the surface of the encapsulant.



11. Disclaimers

- LG Innotek is not responsible for any damages or accidents caused if the operating or storage conditions exceed the absolute maximum ratings recommended in this document.
- The LEDs described in this document are intended to be operated by ordinary electronic equipment.
- It is recommended to consult with LG Innotek when the environment or the LED operation is non-standard in order to avoid any possible malfunctions or damage to product or risk of life or health.
- Disassembly of the LED products for the purpose of reverse engineering is prohibited without prior written consent from LG Innotek. All defected LEDs must be reported to LG Innotek and are not to be disassembled or analyzed.
- The product information can be modified and upgraded without prior notice.